

- ◆ Stainless Steel Sanitary Pipe Fitting
- ◆ Valve、Pump、Fluid Facility
- ◆ 不锈钢卫生级管件、阀门、泵、流体设备



Applications

The centrifugal pump is manufactured in stainless steel and with a shrouded motor. Its sanitary and cost-efficient design makes it perfect for the dairies, beverages, food-processing, pharmaceutical and fine chemicals industries.

Operating principles

Housed inside the casing, the impeller rotates in conjunction with the pump shaft.

With this arrangement, the impeller blades convey energy to the fluid in the form of kinetic energy and pressure energy.

This pump is not reversible by simple reversal of the direction of rotation. The direction of rotation is clockwise when the pump is viewed from the rear side of the motor.

Design and features

Casing manufactured with cold-formed plate.
 Open impeller and close impeller manufactured with stainless steel investment casting.
 Mechanical seal according to DIN 2946 L1K.
 Adjustable stainless steel legs.
 Pump designed according to 3A sanitary standards.
 IEC B34 motors, IP 55, F-class insulation, 50HZ



Materials

Parts in contact with pumped media	AISI 316L/AISI304
Other parts	AISI 304
Gaskets (standard)	EPDM (FDA)
Mechanical seal (standard)	C/SiC/EPDM
Inside surface finishing	Ra 0.8 um
Outside surface finishing	Mirror polished



ABB Motor 2900, 1450 rev./min., 50HZ, 60HZ

Power(KW)	Voltage
0.55	210V~230V / 50HZ 360V~400V / 50HZ 420V~460V / 60HZ
0.75	
1.1	
1.5	
2.2	
3	360V~400V / 50HZ 630V~690V / 50HZ 420V~460V / 60HZ
4	
5.5	
7.5	
11	
15	
18.5	
22	
30	

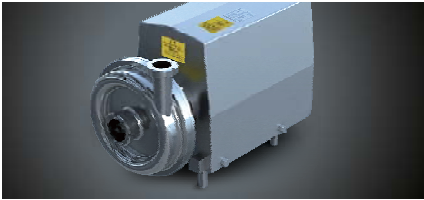

- ◆ Stainless Steel Sanitary Pipe Fitting
- ◆ Valve、 Pump、 Fluid Facility
- ◆ 不锈钢卫生级管件、阀门、泵、流体设备

SANITARY PUMP
卫生级泵



KS Series:

Max. flow 100m³/h
 Max. head 70H(m)
 Max. pressure 7bar / 99PSI

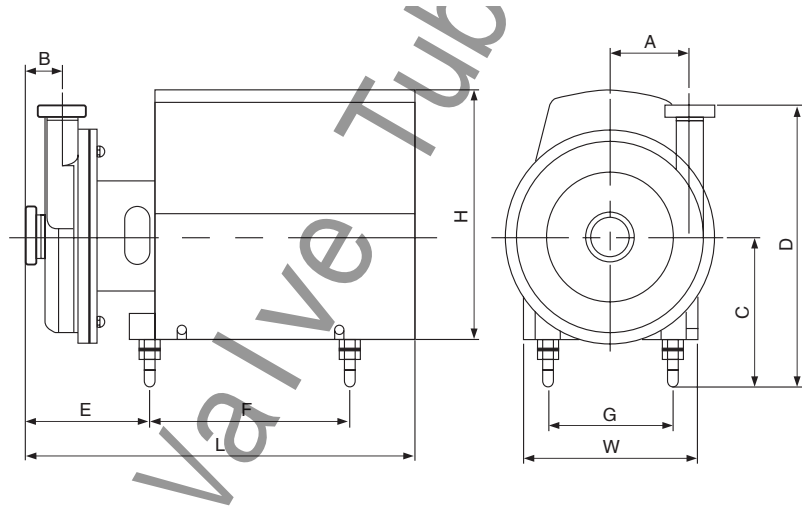

Series KS	Power	Inlet D"/DN	Outlet D"/DN	Assembly Dimension									
				A	B	C	D	E	F	G	H	L	W
KS-5	0.75	1.5" /32	1.5" /32	56	61	160	296	180	200	125	300	465	210
	1.1	1.5" /32	1.5" /32	56	61	160	296	180	200	125	300	465	210
KS-10	1.5	2" /50	1.5" /40	95.6	44	190	343	180	240	140	290	484	210
	2.2	2" /50	1.5" /40	95.6	44	190	343	180	240	140	290	658	210
KS-15	3	2" /50	2" /50	95.6	44	202	358	218	300	160	351	658	260
KS-20	4	2" /50	2" /50	95.6	44	202	358	218	300	190	351	658	260
	5.5	2" /50	2" /50	95.6	46	222	378	238	330	216	380	668	310
KS-25 KS-30	7.5	2.5" /65	2" /50	95.6	46	222	378	238	330	216	380	668	310
	11	3" /80	2.5" /65	163	107	280	430	265	440	254	470	825	360
KS-35 KS-40	15	3" /80	2.5" /65	163	107	280	430	265	440	254	470	825	360
	18.5	3" /80	2.5" /65	163	107	280	430	265	440	254	470	870	360
	22	3" /80	2.5" /65	163	107	330	450	265	450	279	490	895	360
	30	3.5" /100	3" /80	163	107	330	450	265	490	279	490	905	360



- ◆ Stainless Steel Sanitary Pipe Fitting
- ◆ Valve、Pump、Fluid Facility
- ◆ 不锈钢卫生级管件、阀门、泵、流体设备

50Hz

N-2900min

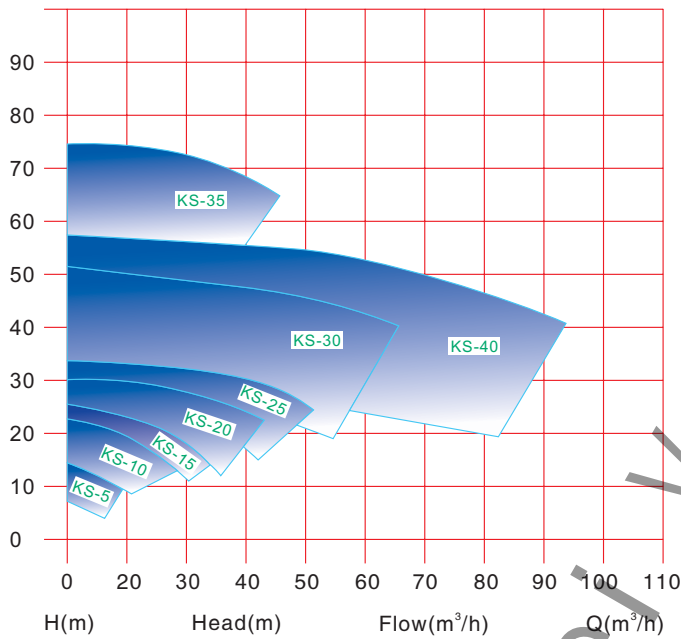

60Hz

N-3600min

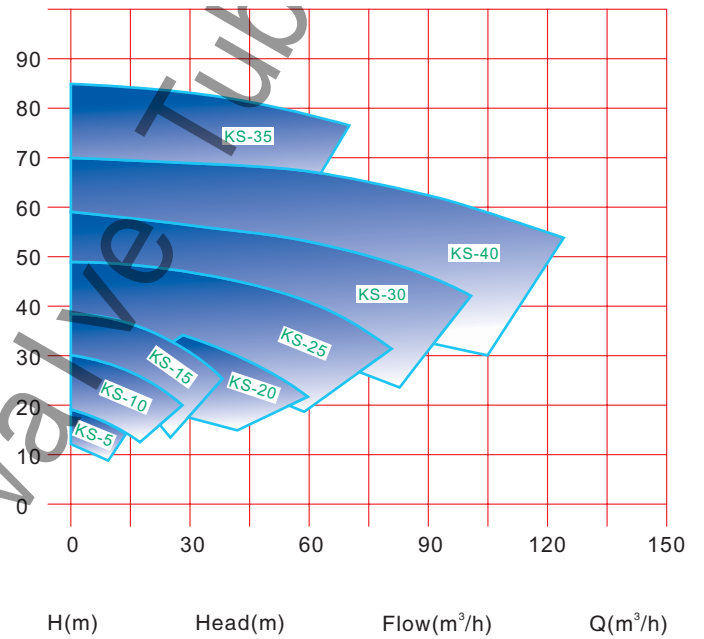

Mechanical Seal

There are three assembly options for KS series pump:

1. Single mechanical seal(standard)
2. Flushed double mechanical seal
3. Flushed single mechanical seal

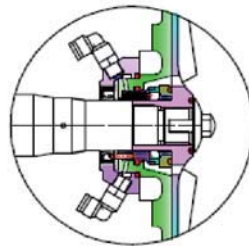
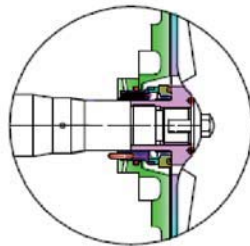
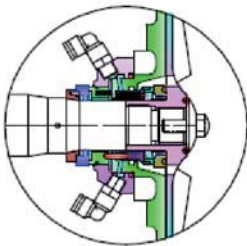

Flushed double mechanical seal Single mechanical seal Flushed single mechanical seal



- ◆ Stainless Steel Sanitary Pipe Fitting
- ◆ Valve、Pump、Fluid Facility
- ◆ 不锈钢卫生级管件、阀门、泵、流体设备

KS5

N-2900min

Medium:20°C water
 Impeller dia.:120mm/110mm
 Inlet dia.:38.1mm
 Tolerance: 5 %
 Frequency:50Hz
 Outlet dia.:38.1mm

Performance Curve:

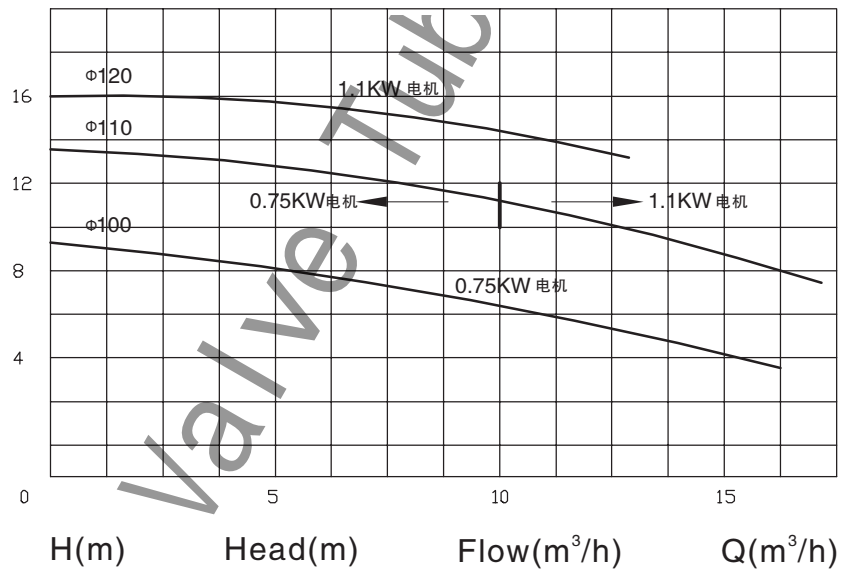

N-3600min

Medium:20°C water
 Impeller dia.:120mm/110mm
 Inlet dia.:38.1mm
 Tolerance: 5 %
 Frequency:60Hz
 Outlet dia.:38.1mm

Performance Curve:

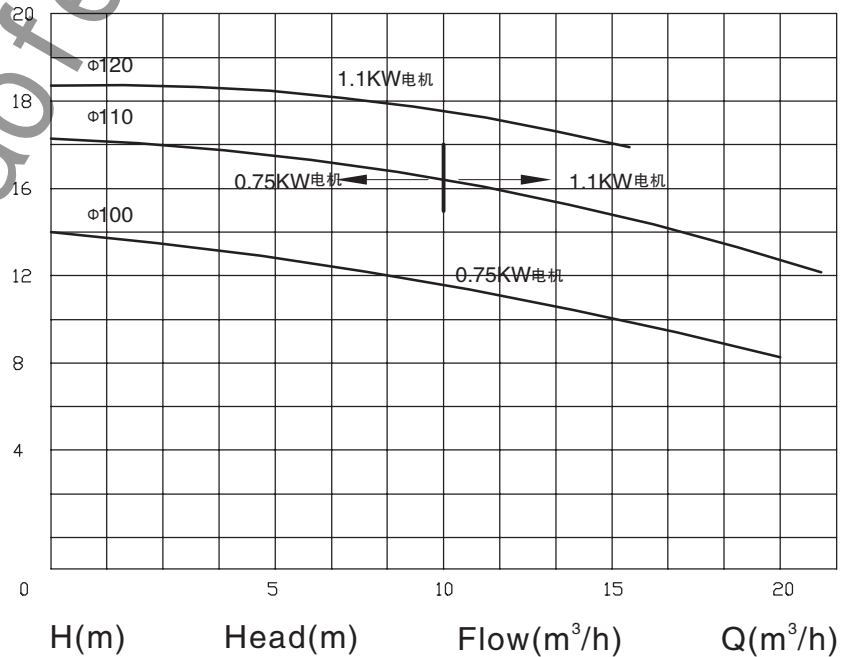

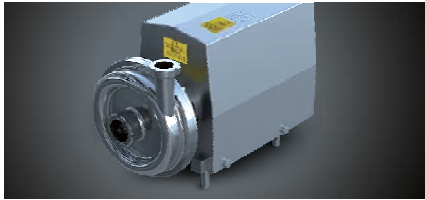

- ◆ Stainless Steel Sanitary Pipe Fitting
- ◆ Valve、Pump、Fluid Facility
- ◆ 不锈钢卫生级管件、阀门、泵、流体设备

KS10

N-2900min

Medium:20°C water
Inlet dia.:38.1mm
Frequency:50Hz

Impeller dia.:140mm/100mm
Tolerance: 5 %
Outlet dia.:38.1mm

Performance Curve:

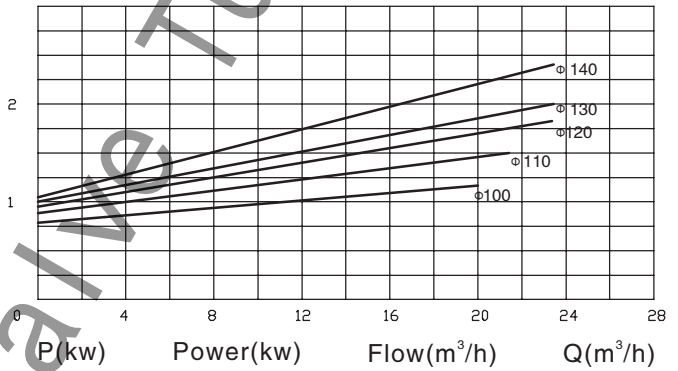
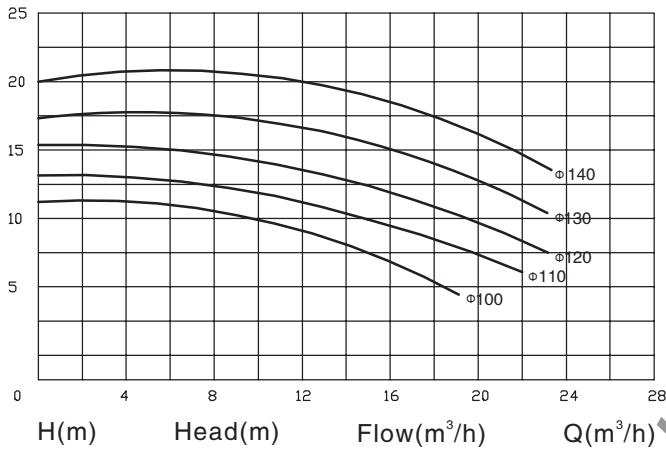

Performance Curve:

N-3600min

Medium:20°C water
Inlet dia.:38.1mm
Frequency:60Hz

Impeller dia.:140mm/100mm
Tolerance: 5 %
Outlet dia.:38.1mm

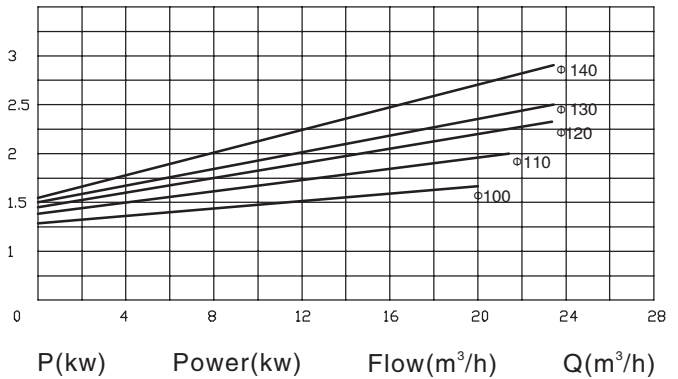
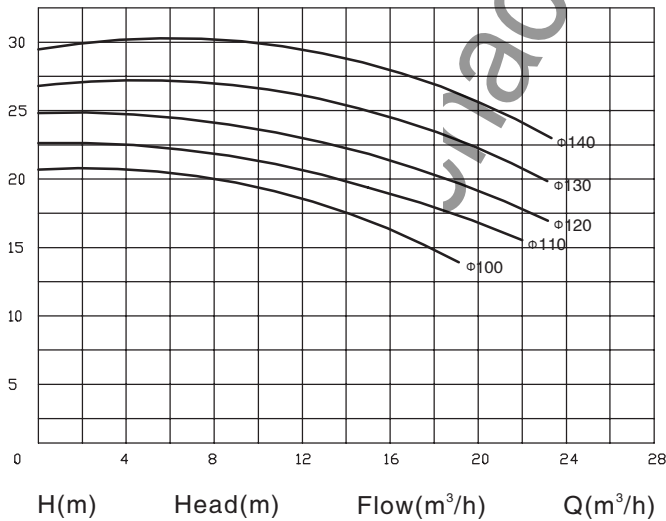

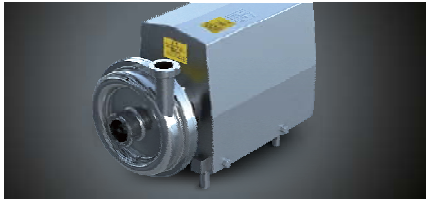

- ◆ Stainless Steel Sanitary Pipe Fitting
- ◆ Valve、Pump、Fluid Facility
- ◆ 不锈钢卫生级管件、阀门、泵、流体设备

SANITARY PUMP 卫生级泵

KS15

Performance Curve:

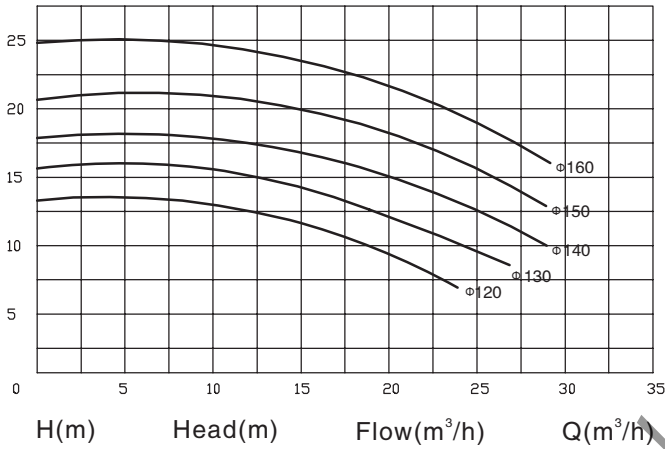

N-2900min

Medium: 20°C water
Inlet dia.: 50.8mm
Frequency: 50Hz

Impeller dia.: 160mm/120mm
Tolerance: 5 %
Outlet dia.: 38.1mm

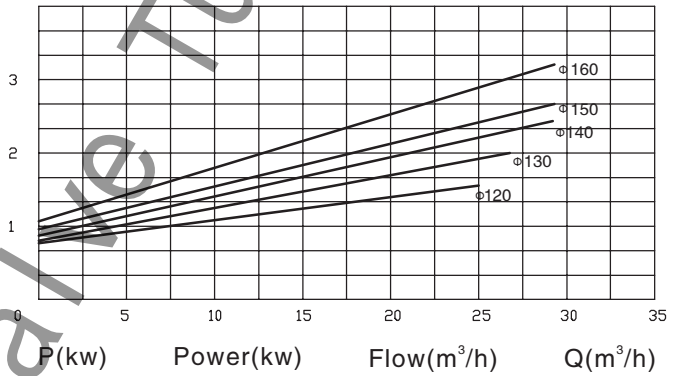

Performance Curve:

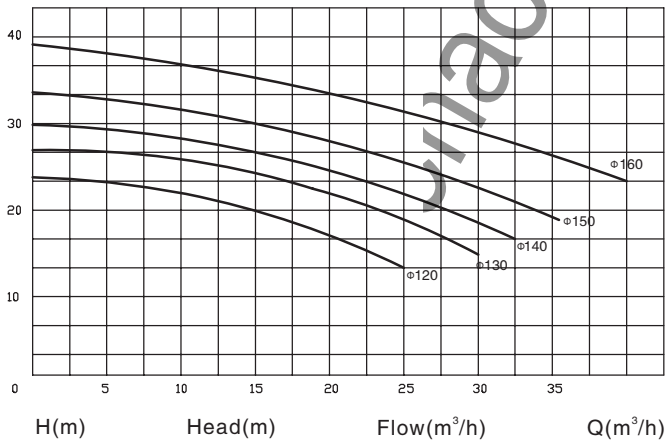

N-3600min

Medium: 20°C water
Inlet dia.: 50.8mm
Frequency: 60Hz

Impeller dia.: 160mm/120mm
Tolerance: 5 %
Outlet dia.: 38.1mm

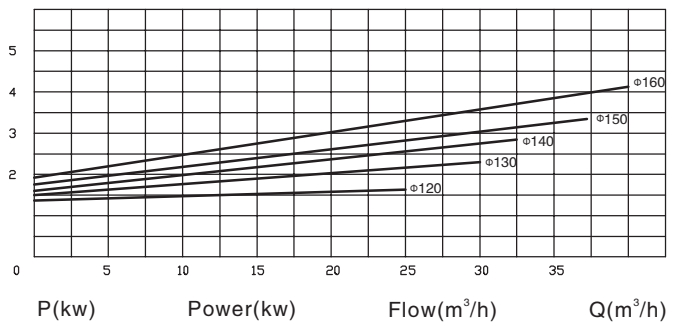

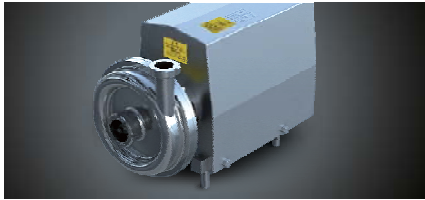

- ◆ Stainless Steel Sanitary Pipe Fitting
- ◆ Valve、Pump、Fluid Facility
- ◆ 不锈钢卫生级管件、阀门、泵、流体设备

KS20

N-2900min

Medium: 20°C water
Inlet dia.: 63.5mm
Frequency: 50Hz

Impeller dia.: 186mm/145mm
Tolerance: 5 %
Outlet dia.: 50.8mm

Performance Curve:

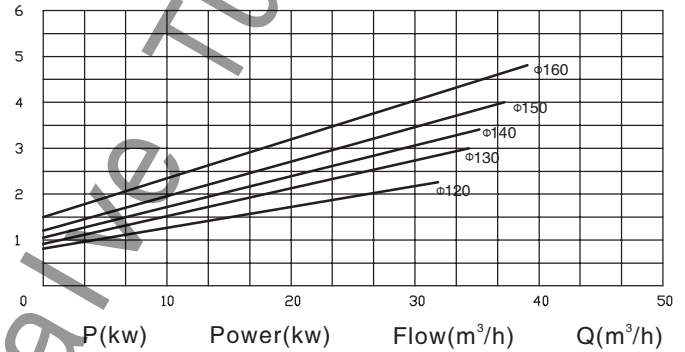
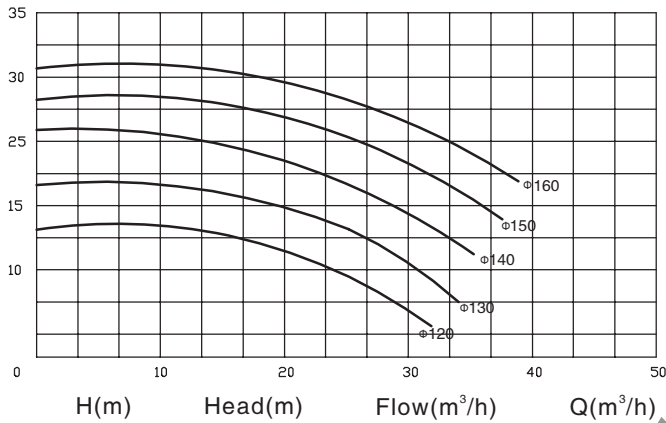

Performance Curve:

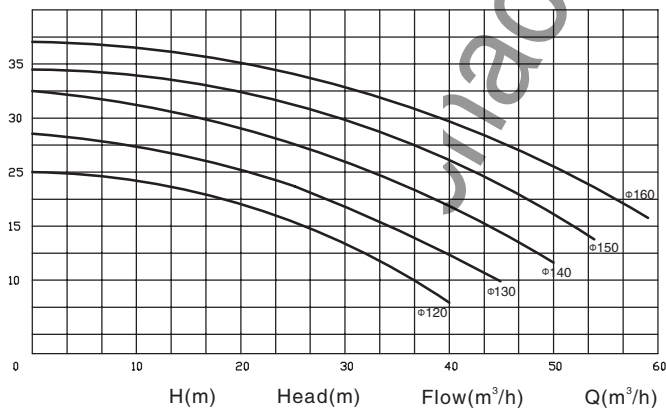

N-3600min

Medium: 20°C water
Inlet dia.: 63.5mm
Frequency: 60Hz

Impeller dia.: 160mm/120mm
Tolerance: 5 %
Outlet dia.: 50.8mm

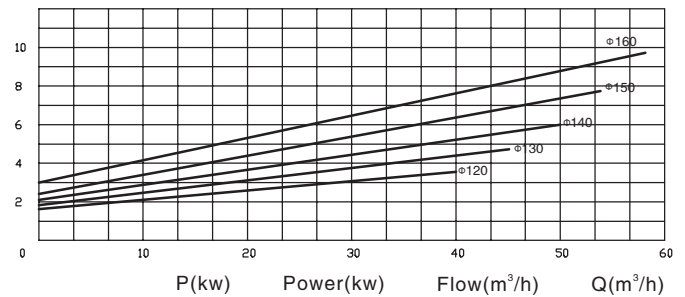



- ◆ Stainless Steel Sanitary Pipe Fitting
- ◆ Valve、Pump、Fluid Facility
- ◆ 不锈钢卫生级管件、阀门、泵、流体设备

SANITARY PUMP 卫生级泵

KS25

Performance Curve:

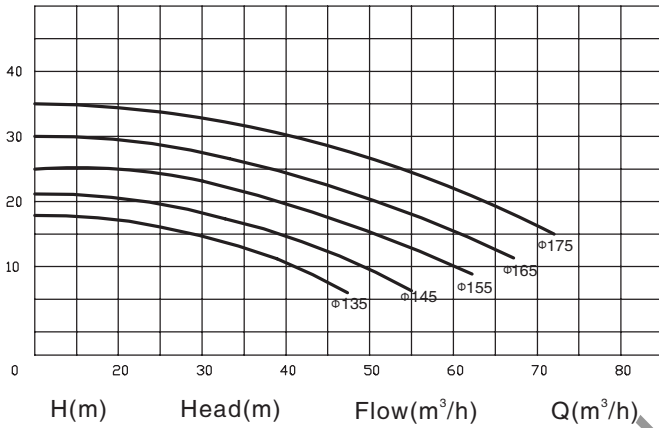

N-2900min

Medium: 20°C water
Inlet dia.: 63.5mm
Frequency: 50Hz

Impeller dia.: 165mm/125mm
Tolerance: 5 %
Outlet dia.: 50.8mm

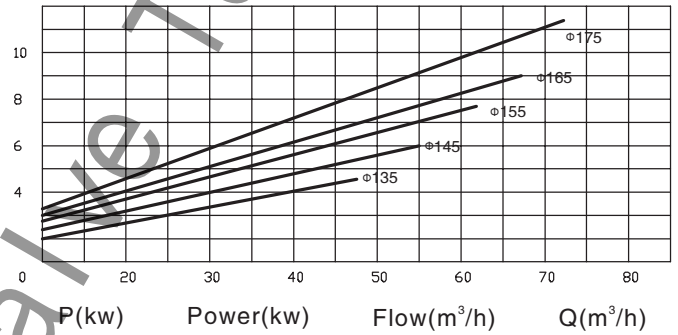

Performance Curve:

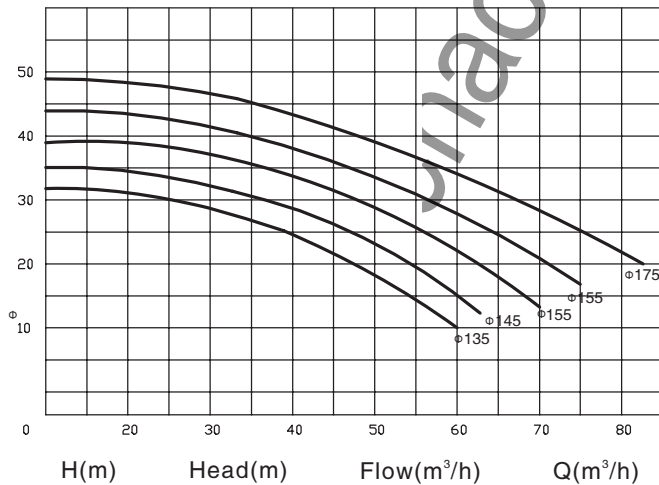

N-3600min

Medium: 20°C water
Inlet dia.: 63.5mm
Frequency: 60Hz

Impeller dia.: 165mm/125mm
Tolerance: 5 %
Outlet dia.: 50.8mm

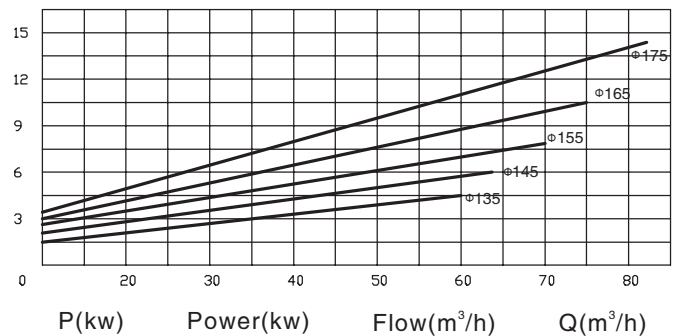

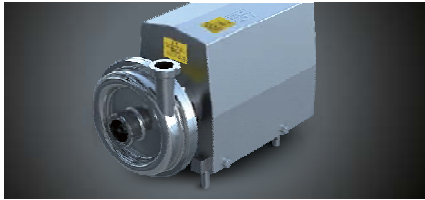

- ◆ Stainless Steel Sanitary Pipe Fitting
- ◆ Valve、Pump、Fluid Facility
- ◆ 不锈钢卫生级管件、阀门、泵、流体设备

KS30

N-2900min

Medium:20°C water
Inlet dia.:63.5mm
Frequency:50Hz

Impeller dia.:190mm/150mm
Tolerance: 5 %
Outlet dia.:63.5mm

Performance Curve:

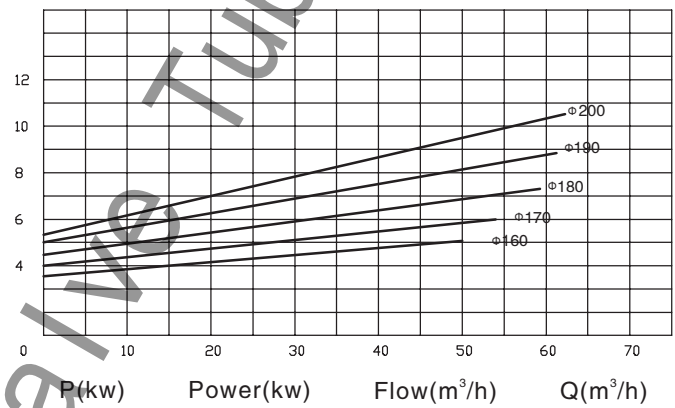
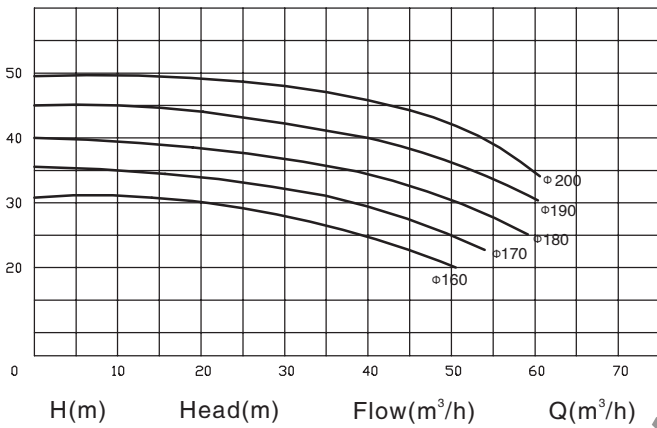

Performance Curve:

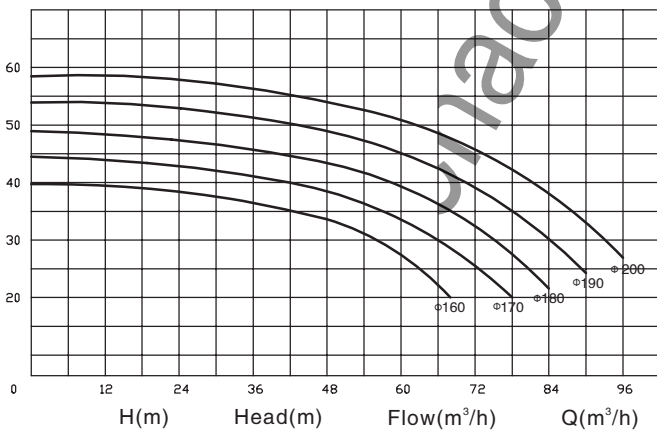

N-3600min

Medium:20°C water
Inlet dia.:63.5mm
Frequency:60Hz

Impeller dia.:190mm/150mm
Tolerance: 5 %
Outlet dia.:63.5mm

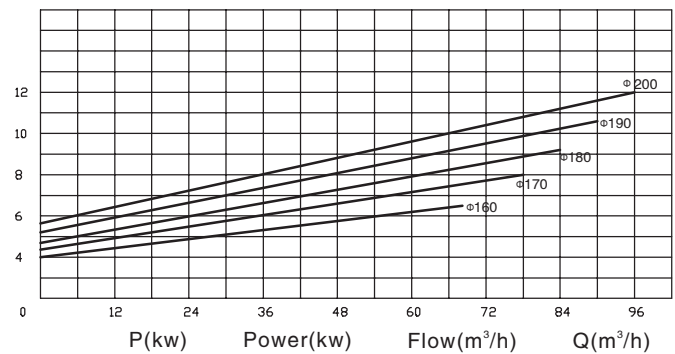

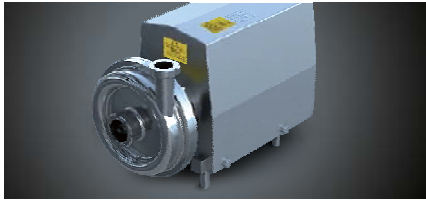

- ◆ Stainless Steel Sanitary Pipe Fitting
- ◆ Valve、Pump、Fluid Facility
- ◆ 不锈钢卫生级管件、阀门、泵、流体设备

KS35

Performance Curve:

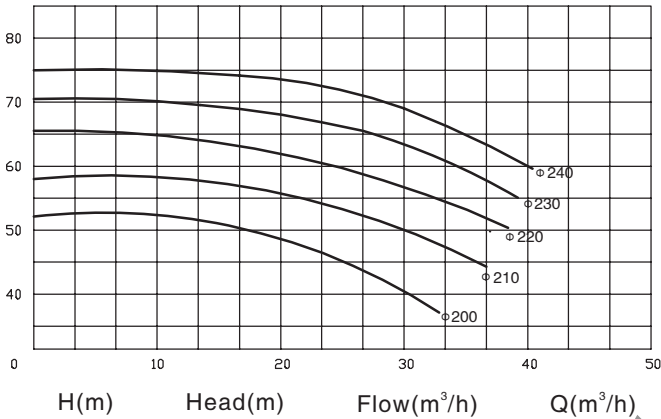

N-2900min

Medium: 20°C water
Inlet dia.: 63.5mm
Frequency: 50Hz

Impeller dia.: 240mm/200mm
Tolerance: 5 %
Outlet dia.: 38.1mm

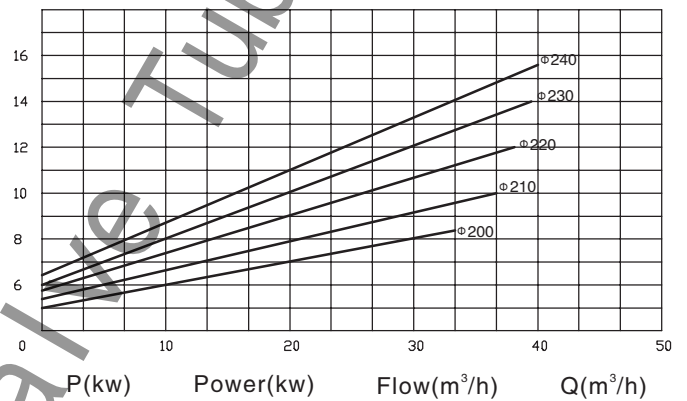

Performance Curve:

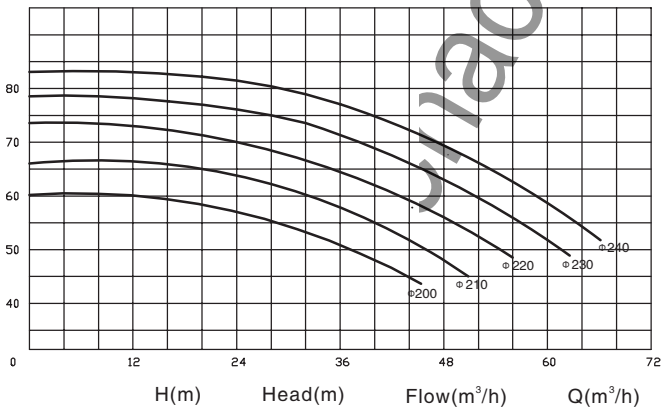

N-3600min

Medium: 20°C water
Inlet dia.: 63.5mm
Frequency: 60Hz

Impeller dia.: 240mm/200mm
Tolerance: 5 %
Outlet dia.: 38.1mm

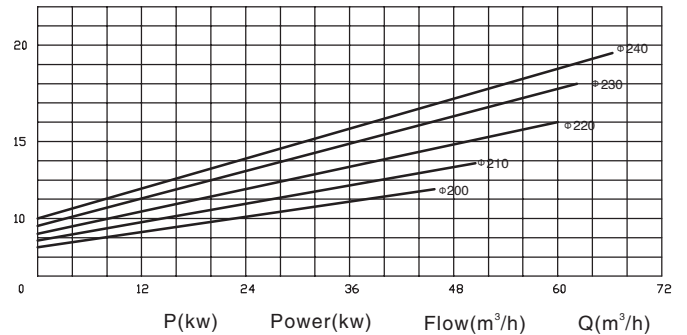

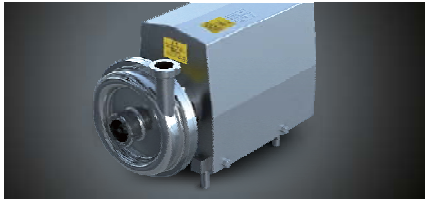

- ◆ Stainless Steel Sanitary Pipe Fitting
- ◆ Valve、Pump、Fluid Facility
- ◆ 不锈钢卫生级管件、阀门、泵、流体设备

KS40

N-2900min

Medium: 20°C water
Inlet dia.: 76.2mm
Frequency: 50Hz

Impeller dia.: 200mm/160mm
Tolerance: 5 %
Outlet dia.: 63.5mm

Performance Curve:

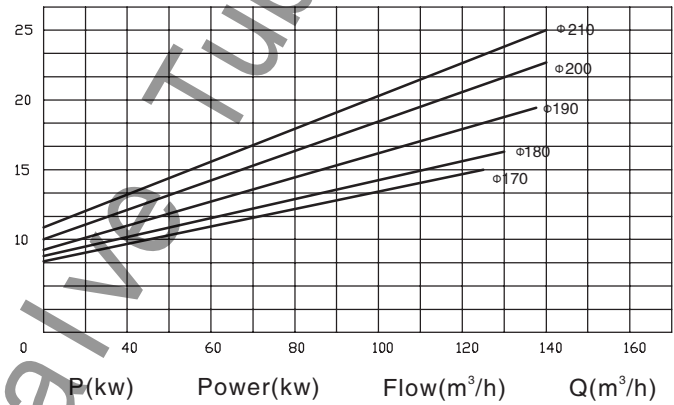
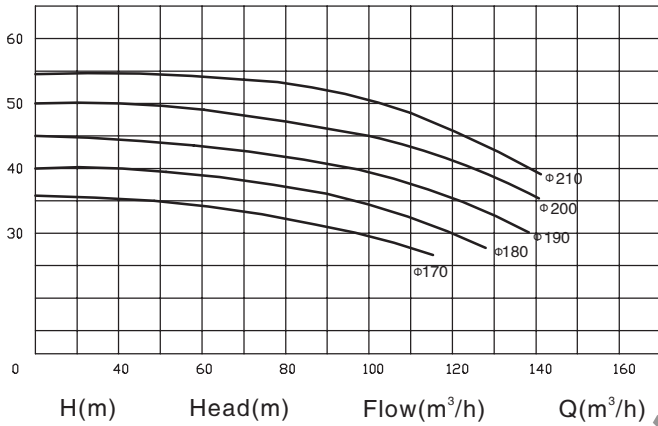

N-3600min

Medium: 20°C water
Inlet dia.: 76.2mm
Frequency: 60Hz

Impeller dia.: 200mm/160mm
Tolerance: 5 %
Outlet dia.: 63.5mm

Performance Curve:

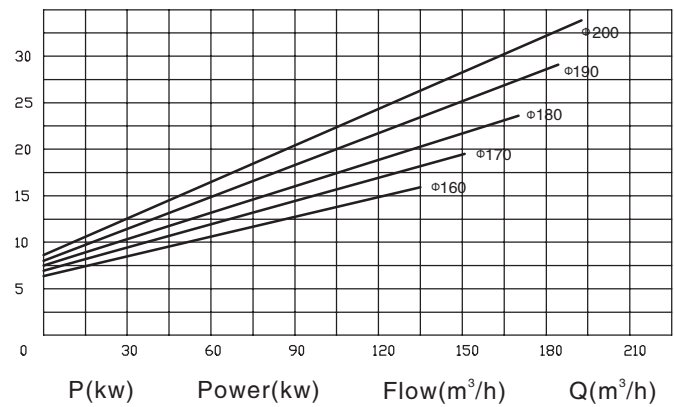
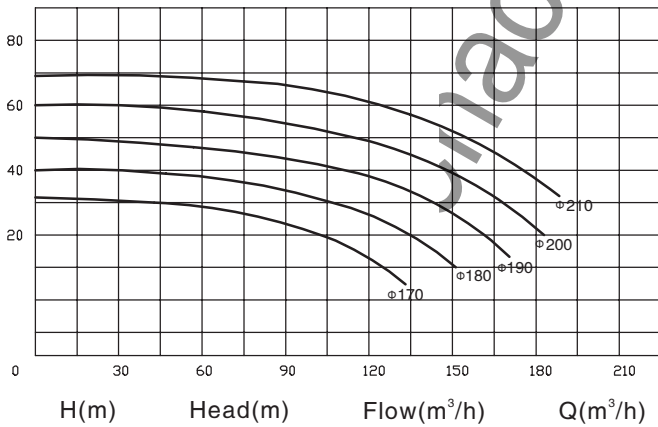

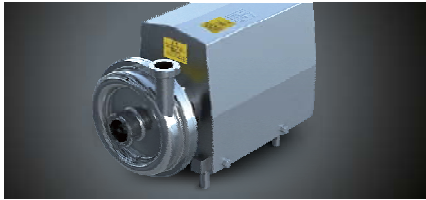

- ◆ Stainless Steel Sanitary Pipe Fitting
- ◆ Valve、Pump、Fluid Facility
- ◆ 不锈钢卫生级管件、阀门、泵、流体设备

卫生级泵
 SANITARY PUMP

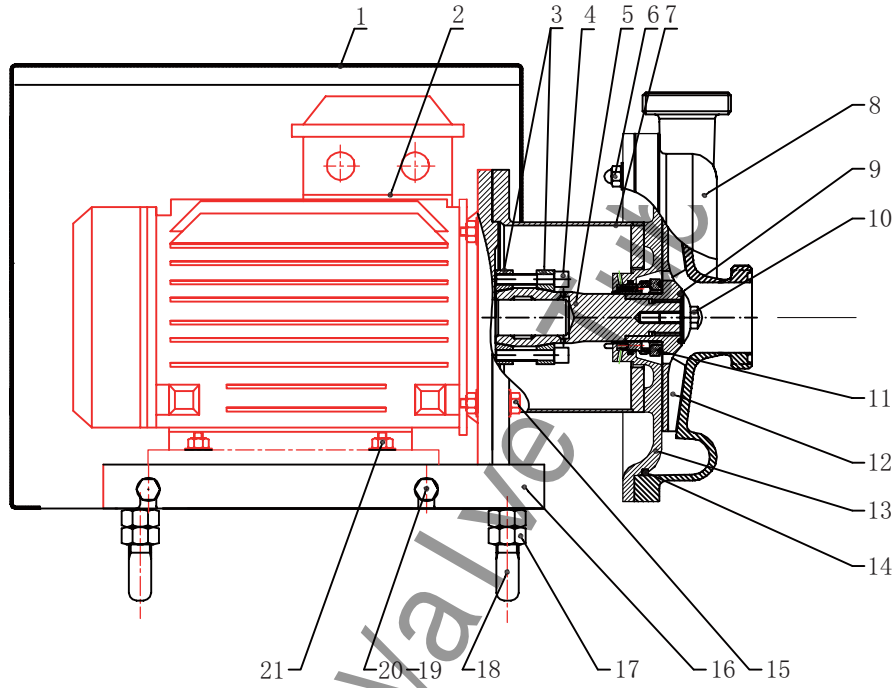

21	GB-70	bolt	304	4
20		nylon washer		4
19	GB-70	hex.bolt	304	4
18	GB-70	foot bolt	304	4
17	GB-70	locked nut	304	4
16	KS-35-011	pump foot	304	2
15	GB-70	bolt	304	4
14	KS-35-010	O ring	EPDM	1
13	KS-35-009	rear cover	304/316L	1
12	KS-35-008	impeller	304/316L	1
11	KS-35-007	mechanical seal		1
10	KS-35-006	impeller screw cap	304/316L	1
9		O ring	EPDM	1
8	KS-35-005	pump head	304/316L	1
7	KS-35-004	connection part	304	1
6	GB-70	screw cap	304	1
5	KS-35-003	pump shaft	304/316L	1
4	KS-35-002	bolt	304	6
3	GB-70	tighten ring	304	2
2		motor		1
1	KS-35-002	pump cover	304	1
Pos.	Part	Name	Material	Qty.



- ◆ Stainless Steel Sanitary Pipe Fitting
- ◆ Valve、Pump、Fluid Facility
- ◆ 不锈钢卫生级管件、阀门、泵、流体设备



Applications

The pump is a sanitary, side-channel, self-priming pump suitable for use in the food-processing, pharmaceutical and chemical industries.

It is specially designed for pumping materials containing air or gas, and it can also be used for negative suction with prior priming as well as with filtration equipment.

It can be used with wine, oil, syrups, volatile products such as alcohol, acetone and other solvents, or with products at temperatures close to boiling point. However, the main use of this pump is for CIP return.



Operating Principles

The impeller is housed between the inlet body and the venturi casing and it rotates in conjunction with the pump shaft. This arrangement, together with pump shaft. This arrangement, together with the rotation of the impeller and arrangement of the side channel, creates a negative pressure inside the inlet body, which generates the suction force of the pump. At the same time, the fluid receives energy in the form of kinetic energy and pressure energy, and this impels it through the impeller casing.

Design and features

Casing manufactured with cold-formed plate.
Stainless steel investment casting inlet body and impeller.
Mechanical seal prevents contacting between the springs and the pumped fluid
Stainless steel pump support



Materials

Parts in contact with pumped media	AISI -316/304
Other parts	AISI-304
Gaskets (standard)	EPDM (FDA)
Mechanical seal (standard)	C/SiC/EPDM
Internal surface finish	Polished
External surface finish	Sandblast

Options

Mechanical seal in SiC/SiC
Gaskets in FPM(Viton) and PTFE
Inlet & outlet connections: Clamp, Thread, Flange, DIN, SMS, 3A, RJT

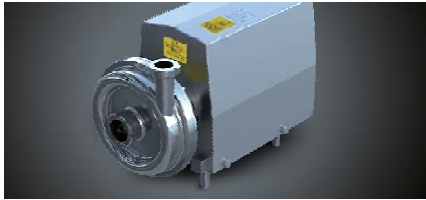

- ◆ Stainless Steel Sanitary Pipe Fitting
- ◆ Valve、Pump、Fluid Facility
- ◆ 不锈钢卫生级管件、阀门、泵、流体设备

SANITARY PUMP 卫生级泵



Technical specifications

Max.flow 30 m³ /h / 132 GPM
 Max.head 24H(m)
 Max.pressure 3 bar/43 PSI
 Max.operating temp. 120°C/ 248 F
 Max.speed 1750 min
 Max.suction height 8m / 22 ft
 Motor type: B35, Motor frequency 50HZ/60HZ.
 Motor power(KW) refer to table below:

Power(KW)	Motor	Power(KW)	Motor
0.75	210V~230V/50HZ	4	360V~400V/50HZ
1.1		5.5	
1.5	360V~400V/50HZ	7.5	630V~690V/50HZ
2.2	420V~460V/60HZ	11	420V~460V/60HZ
3		15	

Assembly Dimension

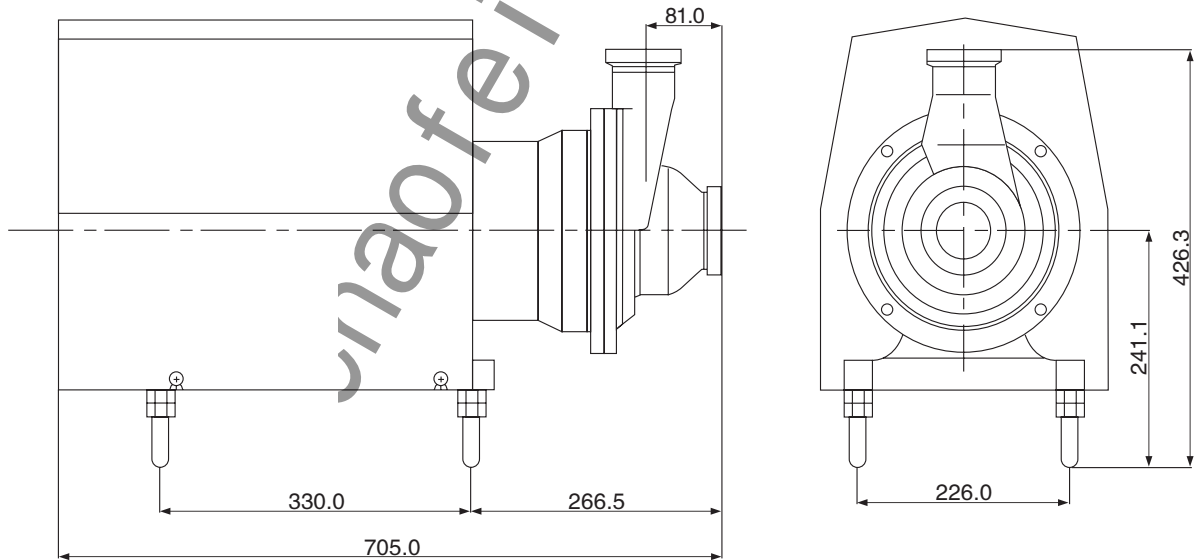



- ◆ Stainless Steel Sanitary Pipe Fitting
- ◆ Valve、Pump、Fluid Facility
- ◆ 不锈钢卫生级管件、阀门、泵、流体设备

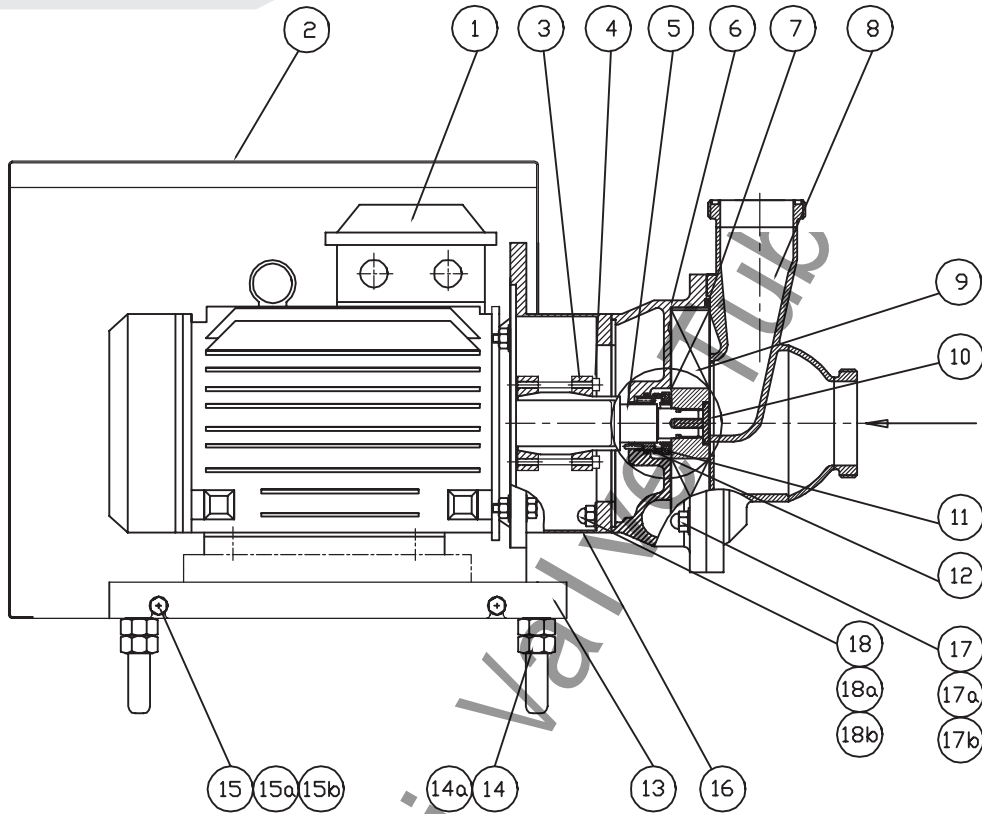

19		O ring	EPDM	1
18b		Screw cap	304	2
18a		Washer	304	2
18		Screw cap	304	4
17b		Screw cap	304	4
17a		Washer	304	4
17		Screw cap	304	4
16	CIP-011	Connection part	304	1
15b		Washer	304	4
15a		Bolt	304	4
15		Bush	nylon	4
14a		Screw cap	304	8
14		Bolt	304	4
13	CIP-010	Pump foot	304	1
12	CIP-009	Stationary ring		1
11	CIP-009	Rotary ring		1
10	CIP-008	Impeller bolt	304/316L	1
9	CIP-007	Impeller	304/316L	1
8	CIP-006	Pump head	304/316L	1
7	CIP-005	Seal	EPDM	1
6	CIP-004	Pump body	304/316L	1
5	CIP-003	Pump shaft	304/316L	1
4		hex.bolt	304	6
3	CIP-002	Tighten ring	304	2
2	CIP-001	Pump cover	304	1
1		Motor		1
Pos.	Part	Name	Material	Qty.

